

OWNER'S MANUAL

1531000

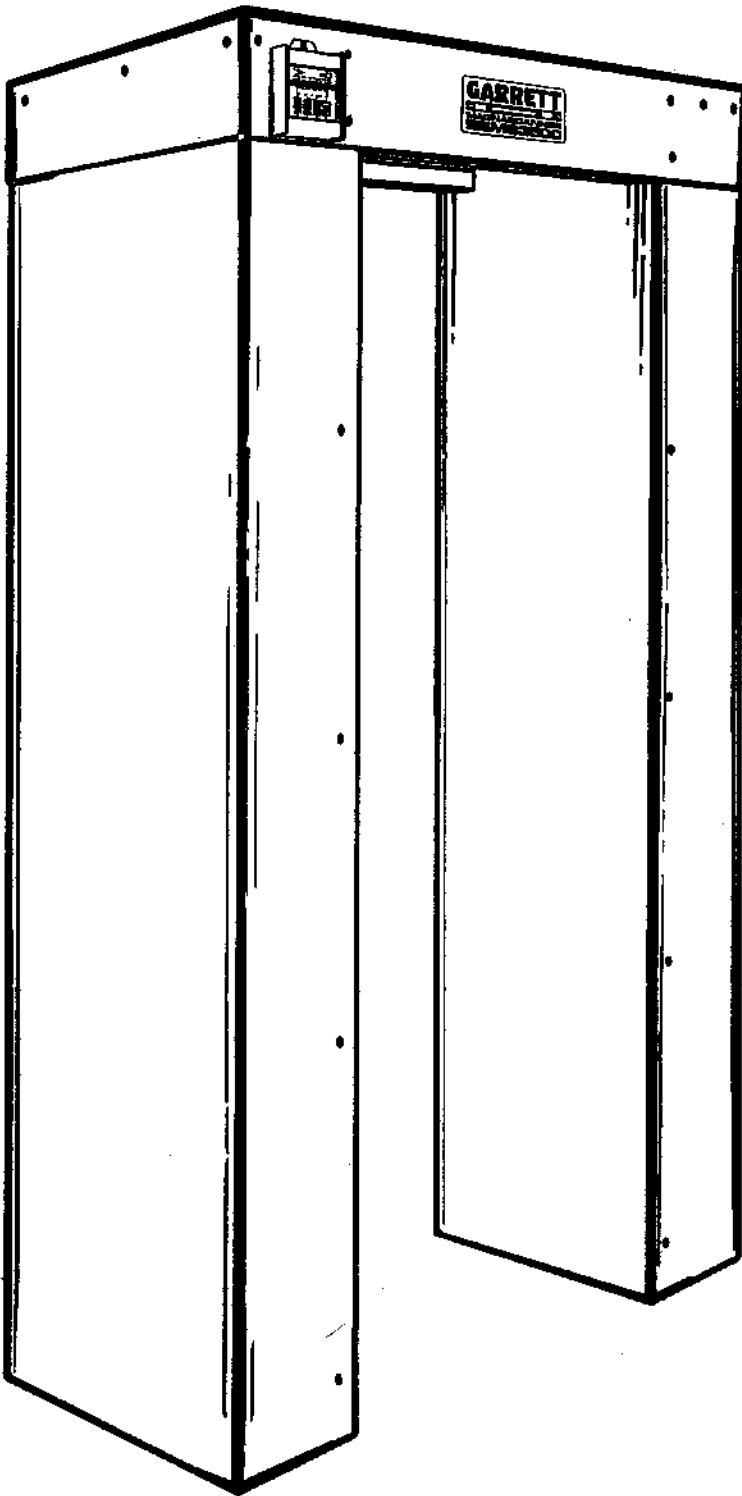

GARRETT

MAGNASCANNER MS 3500

MODEL 1167200

Garrett Metal Detectors, Inc.
1881 W. State Street
Garland, TX 75042-6797 USA
Tel: 972-494-6151 or 800-234-6151
Fax: 972-494-1881
e-mail: security@garrett.com

STANDARD SETUP AND OPERATION PROCEDURE

If you are not familiar with the Magnascanner, it is recommended that you view the Video that accompanied this unit before beginning this checklist. To prepare the Magnascanner for use...

YOU MUST:

- 1. Assemble unit and move to desired location. Make necessary arrangements of surrounding furniture and equipment. (See Site Selection, Page 6.) Attach cables necessary for remote consoles, multiunit slaving, or control relays.
- 2. Connect unit to power source and observe LCD panel. The unit will begin the self test sequence automatically when power is connected. Correct any problems reported. (See Self-Diagnostic Tests, Page 9.)
- 3. Determine optimum program based on your particular application. (See Programs, Page 34.)
- 4. Set unit to desired program (See Supervisor Adjustments, Program, Page 14.)
- 5. Determine sensitivity setting required, using the alarm level reading and sample test objects selected for your application. Be thorough; perform the test at various elevations and orientations for objects that produce the highest alarm level readings. (See Supervisor Adjustments, Alarm Level Reading, Page 14.)
- 6. Set sensitivity to value determined in step 6.2 (See Supervisor Adjustments, Sensitivity, Page 14.)
- 7. Return to Operate Mode by pressing **OPERATE** touchpad.
- 8. Perform verifications test using selected objects. (See Supervisor Responsibilities, Page 15.)

YOU MAY ALSO:

- 9. If multiple unit operation is being utilized, verify units are properly interleaved. (See Multiple Unit Operation, Page 35.)
- 10. If unit appears noisy, i.e. more than two LED's persistently displayed on bar graph, further adjustments are required, proceed to Step 11. If unit appears quiet, proceed to Step 13.
- 11. Adjust video filter until noise subsides. (See Installation Adjustments, Video Filter, Page 12.)
- 12. Repeat steps 4-8.
- 13. Adjust tone to desired level. (See Installation Adjustments, Tone, Page 11.)
- 14. Adjust volume to desired level. (see Operating Instructions, Volume, Page 4.)
- 15. Alter access codes, if desired. (See Installation Adjustments. Alter Access Code #1 and #2, Page 12.)

SECURITY

When used in a security (weapons detection) application, it is important that the following procedures be followed:

1. Determine the security level appropriate to the application.
2. Select test object(s) that will allow calibration and verification of the desired settings.
3. Maintain the Operation Work Sheet shown on Page 31 of this booklet.
4. Using the same test objects, verify the calibration daily and any time the equipment is moved or the operating environment changes.
5. Seek corrective action immediately for any problems or performance deficiencies and report problems/deficiencies to the sales representative and manufacturer as well.

Magnascanner, Super Scanner and Enforcer G-2 are TM of Garrett Electronics, Inc. If further assistance is required, call the factory at 1-800-234-6151.

TABLE OF CONTENTS

1.	GENERAL DESCRIPTION	1
2.	CONTROLS & MODULES	
2.1.	DISPLAY PANEL	2
2.2.	TOUCHPADS	3
2.3.	INTERNAL MODULES	5
3.	INSTALLATION INSTRUCTIONS	
3.1.	SITE SELECTION	6
3.2.	ASSEMBLY	7
4.	SELF-DIAGNOSTIC TESTS	9
5.	INSTALLATION ADJUSTMENTS	11
6.	SUPERVISOR ADJUSTMENTS	13
7.	SUPERVISOR RESPONSIBILITIES	15
8.	TECHNICAL SPECIFICATIONS	17
9.	MAINTENANCE & REPAIR	21
9.1.	PERIODIC MAINTENANCE	21
9.2.	REPAIR	21
9.3.	MODULE REPLACEMENT	21
9.4.	REPLACEMENT PARTS	23
9.5.	WARRANTY	24
10.	OPERATING INSTRUCTIONS	24-30
11.	ADDITIONAL INFORMATION	31
11.2.	PROGRAMS	32
11.3.	MULTIPLE UNIT OPERATION	35
11.4.	AC & DC CONTROL	36
11.5.	BATTERY BACK-UP MODULE	39
11.6.	REMOTE CONSOLES	40
12.	ELECTRICAL WIRING REQUIREMENTS.....	41

Caution: Read This Before Operating.

For best possible operation, read this manual carefully.

An optional Floor Mounting Kit, Part Number 1604000, is available and may be used to anchor the detector. It is recommended that this base be used in outdoor applications or where there is danger of the unit being pushed over. Be sure to follow installation directions carefully.

Electrical requirements:

Fully automatic 100 to 240 VAC, 50/60 Hertz, 5 Watts, no rewiring or switching required. For security purposes, the AC disconnect is located inside the detector housing and is accessible only to operating and/or maintenance personnel.

Always place the metal detector on a level stable floor that is not subject to movement or vibration.

Do not drive nails or drill holes into the side panels.

Position away from rain, mist and condensation.

Use caution when placing the metal detector next to telephone systems, television monitors, electric motors, transformers, power cables, or control circuits. Excessive electrical noise will show activity on the LED bar graphs. This situation should be avoided whenever possible.

Security type metal detectors are important tools, designed for use within a total security screening system. It is the responsibility of the end user to define the system and to ensure proper operation of all aspects of the system.

1. GENERAL DESCRIPTION

The Garrett Magnascanner MS 3500 Walk-through Metal Detector features micro-processor-controlled circuitry and LCD presentation of all calibrating and operating information. It is capable of remote operation and monitoring, when required. The unit can be operated on battery power alone through use of an optional battery pack.

The detector is manufactured by Garrett Metal Detectors at its factory in Garland, a suburb of Dallas, Texas.

The Magnascanner MS 3500 was designed specifically to stand up to the everyday demands of jails, prisons, and other facilities requiring maximum security protection with little downtime for repairs. Or, for any venue where weather is a factor. This new, heavy-duty, weatherproof walk-through was built to withstand outside weather conditions or rough handling anywhere, while giving consistently reliable screening.

The secret to its durability is in its construction and design. The Overhead Cap Assembly, which sits atop the detector, features a one-piece design that leaves no openings through which neither weather nor curious fingers can penetrate. All the detection electronics are housed in this one-piece assembly and protected by a key lock. Like the rest of the detector, this housing is also made of armor aluminum sheets. The Ready Light, the Alarm Light and the Bar Graph LED are located on the face of the Overhead Cap Assembly and are protected with heavy Plexiglas.

The Movable Keypad Control Unit can be located inside the locked and weathertight Overhead Cap Assembly of the unit, or can be attached to the exterior of the unit for easy access.

The Magnascanner MS 3500 uses microprocessors in both its detection and control circuitry. These integrated circuits contain the necessary elements of a small digital computer and are preprogrammed to provide discrimination capabilities that enable the Magnascanner to optimally detect weapons and other devices made of metal. At the same time, the microprocessors permit the detector to be considerably more sophisticated in its programming and provide greater flexibility in the selectivity of the metals it detects. The detector also features excellent sensitivity, stability and noise rejection. All electronics are modularized for easy serviceability, and housed inside the Overhead Cap Assembly. This positioning eliminates problems of logistics and reliability often associated with a cable-connected console. A bright LED bar graph, easily seen from a distance, indicates Ready and Alarm conditions.

All regulation and control functions are "self-prompting" with necessary commands shown automatically on the LCD. The system offers highly flexible capabilities with a continuously variable range of programs, including several that have been designed for specific purposes. Programs are regulated by state-of-the-art touchpads and reported visually on the LCD. Improved security of the unit's detection settings comes from a

system of dual access codes. Two levels of codes are used for added protection. Access Code #1 is used by supervisors for selecting programs and sensitivity, with Access Code #2 designed for initial setup and overall control. All settings are encoded by touchpads and remembered in a resettable memory. Security of the unit's calibration settings is further protected by a non-resettable sequence code that allows supervisors to keep a log of all changes that are ever made as well as any unsuccessful attempts to change them. In addition, a tamper indication reports any unauthorized attempts at access. A complete and automatic self-diagnostic program is carried out by the Magnascanner MS 3500 each time the Operate touchpad is pressed. In addition, the detector utilizes self-testing circuitry that continuously monitors the critical functions of the detector, reporting automatically the failure of any element that would affect operation of the unit.

2. CONTROLS AND MODULES

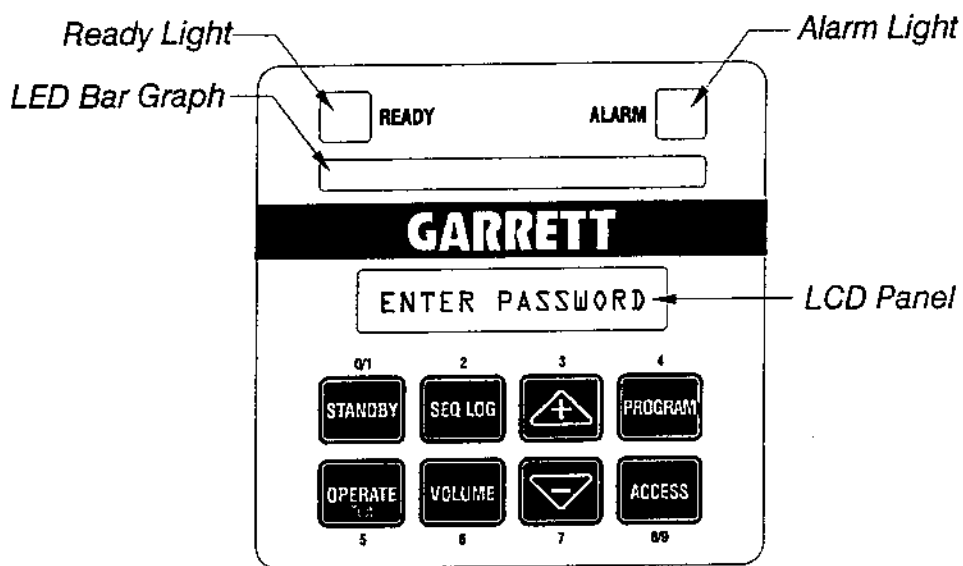

2.1. MOVABLE KEYPAD CONTROL UNIT

Located inside the locked Overhead Cap Assembly for security, or can be attached to the exterior for easy access of controls.

2.1.1. LED BAR GRAPH

This LED display at the top of the Overhead Cap Assembly and Movable Display KeyPad Control Unit indicates the detection intensity which is based on the amount and composition of metallic objects passing through the unit.

2.1.2. READY LIGHT

This green light appears when full power has been turned on and the unit is ready to operate. The light will also indicate when an individual inspection has been completed by the unit and it is ready to accept the next person. Operators should make certain the green light is visible before any individual is permitted to pass through the detector.

2.1.3. LCD PANEL

Large backlit alpha/numeric LCD display on the Movable KeyPad Unit reports (in words) all regulating, controlling and self-prompting functions. Backlighting makes it easier to read this data in all lighting conditions.

2.1.4. ALARM LIGHT

This red light appears when the unit detects a targeted amount of metal on an individual, according to specifications of the *Program* and *Sensitivity* levels that have been selected. Operators should be instructed to respond to all alarms. For any detector to be effective in a security system it is absolutely necessary that the cause of EVERY ALARM be determined. (SUPERVISOR'S NOTE: If the Keypad Display is attached to the exterior of the unit, you can adjust the volume of the Alarm by pressing the Volume touchpad. Then by using the + and - touchpads, regulate the volume. Then, press Operate to return to normal operation.)

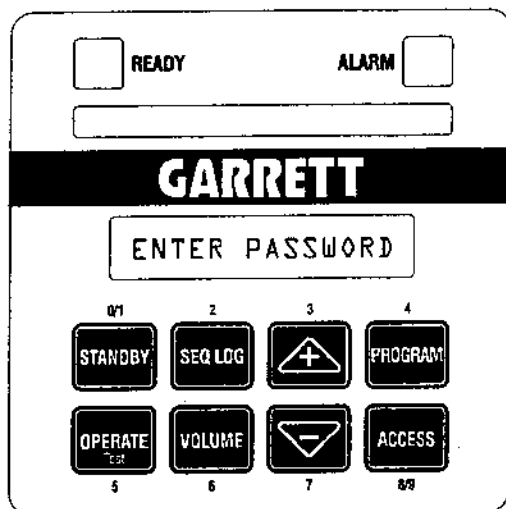

2.2. TOUCHPADS

Eight touchpads on the Movable Display Keypad Unit perform all control functions:

2.2.1. STANDBY

When this touchpad is pressed, the unit goes into a low power mode, ready to be returned to full operation when the **OPERATE** pad is touched. When **STANDBY** is displayed on the LCD, the green **READY** light is not visible and no processing can take place in the unit. It is important to remember that the Power Switch located on the Battery Back-up Module (See Page 39) should be set to its **OFF** position anytime the system is being stored and anytime the system is not in use and is not connected to AC power for more than 24 hours.

2.2.2. OPERATE

Whenever this touchpad is pressed, the Magnascanner MS 3500 activates all circuits, initiates a self-diagnosis program and places the unit in the Operate Mode within fifteen (15) seconds. This diagnostic program for instant fault detection can be activated at any time by touching this **OPERATE** pad. If any faults are ever found, they will be immediately reported on the LCD display. (See Page 9.)

2.2.3. LOG ACCESS

When the touchpad is pressed, the ACCESS LOG number is displayed on the LCD display.

Each time the Installation Adjustment or Supervisor Adjustment mode is accessed, the log count advances by one number. It is recommended that a written notification be made on the Operations Worksheet (See Page 31) whenever the Access Code is accessed, explaining the reasons for the access. If the ACCESS touchpad has been pressed and an improper access code has been entered, a * will appear before the sequence number (SEQ*37). This indicates that an unsuccessful (unauthorized) attempt has been made to gain access to the Installation Adjustment or Supervisor Adjustment setting.

2.2.4. VOLUME

When this touchpad is pressed, the volume level of the unit's audible alarm will be shown on the LCD display and the actual volume of the alarm will be heard. The + and — touchpads can be used by operators to raise or lower the volume. They should then press **OPERATE** to return to the operate mode.

2.2.5. + AND —

These touchpads will be used to increase or decrease various numerical settings.

2.2.6. PROGRAM DISPLAY

When this touchpad is pressed, the settings for *Program* and *Sensitivity* will appear on the LCD display.

SPECIAL NOTE

The above touchpad functions will be available to operators of the detector at all times if the Movable Keypad is mounted on the exterior. Additional functions such as program and sensitivity settings and other adjustments necessary only at installation time may be selected by pressing the ACCESS touchpad and entering a security code.

2.2.7. ACCESS

The **ACCESS** touchpad will be used only by supervisory management personnel. It permits changing the *Program* and *Sensitivity* codes and also is used to control such functions as synchronization of multiple units, pulse frequency, tone, etc. (See Page 11). The unit further protects security of control settings by maintaining a non-resettable sequence code that indicates any attempt at seeking access to the settings. When this touchpad is pressed, audio of the system will "chirp" and *ENTER CODE* will be displayed on the LCD, prompting the operator to enter an access code. If no attempt is made to enter a code, the unit will continue chirping for ten (10) seconds and return to Operate Mode. If the operator enters an incorrect code, audio will sound a Tamper Alarm and *ACCESS DENIED* will appear on the LCD for five (5) seconds. An asterisk (*) will appear on the Sequence Counter indicating that an unsuccessful attempt has been made to access the Installation or Program/Sensitivity Modes of the unit. *Operators should never touch this control.*

If an operator should inadvertently press the **ACCESS** touchpad, no further action should be taken and the unit will return automatically to the Operate Mode in about ten (10) seconds.

2.3. INTERNAL MODULES

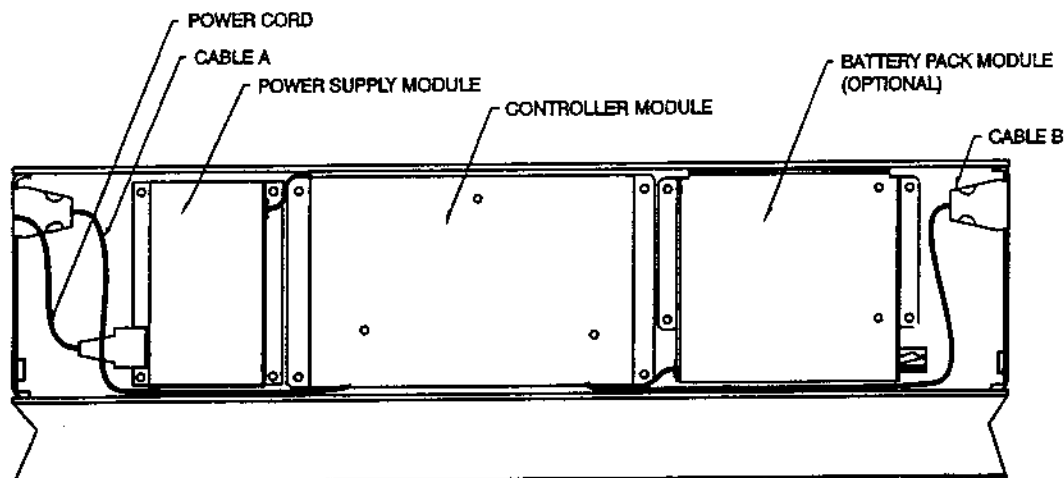

2.3.1. CONTROLLER MODULE

This module (in the center) contains all circuit boards necessary for operation of the detector. Two cables (A and B) that connect this module to the side panels are to be plugged into the connectors at the top of each panel. The cover of the **Controller** Module never needs to be removed except for:

- Connecting wires to remote alarm relays or synchronization circuitry (See Pages 35-38);
- Connecting desktop control console (See Page 40);
- Attaching the optional battery back up (See Page 39);
- Resetting to factory default Access Code (See Page 13).

Shown above is a view of the detection unit after the access door has been opened. Three metal covers protect (from left) the **POWER SUPPLY** Module, **CONTROLLER** Module and the **BATTERY PACK** Module (Optional).

2.3.2. POWER SUPPLY MODULE

This module contains all circuitry that relates to the power required for operation of the detector. The Power Cord should be plugged into the Power Supply Module at the connector on the lower left side. For security purposes, the AC disconnect is located inside the detector housing and is accessible only to operating and/or maintenance personnel.

2.3.3. BATTERY PACK MODULE (OPTIONAL)

This module, which includes two (2) 12v batteries and charging circuitry that comprise the optional battery pack, will be stored behind this cover and connected with the Controller Module. This pack has a switch which is used to disconnect battery power.

This switch need be placed in the *OFF* position only during storage or when the unit is not being used and is not connected to AC power for more than 24 hours. See Page 39 for installation instructions.

3. INSTALLATION INSTRUCTIONS

3.1. SITE SELECTION

The Garrett Magnascanner MS 3500 should be located on a level, stable floor with no large metal items within three (3) feet. Any nearby large metallic object can interfere with operation of the detector. Moving metallic objects, such as an escalator or revolving door, close to the detector can cause false alarms. Such alarms can also be caused by electrical interference from radio telephones, television monitors, powerful electronic motors and transformers, power cables and control circuits.

Garrett's special built-in circuitry is designed to suppress much of this electronic noise, especially X-ray monitor horizontal synchronization signals and closed circuit television. Multiple frequencies permit several Magnascanner units to operate simultaneously, in close proximity.

For information concerning the operation of multiple units, see Page 35.

An optional Floor Mounting Kit (Parts No.1604000) is available and may be used to anchor the detector. It is recommended that this base be used in outdoor applications, or where there is danger of the unit being pushed over. Be sure to follow installation instructions carefully.

The site for a Magnascanner MS 3500 should be selected with requirements for its pedestrian traffic and use in mind; i.e. space for waiting lines, operators and areas for hand-scanning. Although the detector is effective with traffic moving in either direction, best results are obtained when traffic enters from the side opposite to the control touchpads and LCD display. Protect the power cable from pedestrian as well as vehicular traffic.

3.2. ASSEMBLY

1. Lay out the major pieces of the Magnascanner MS 3500, as shown at the right. Make certain all other attachment devices are included. These should include:

- Detection Panel A
- Detection Panel B
- Overhead Cap Assembly
- 1/4-20-x1" Allen Screws (22)
- Finishing Washers(22)
- 5/32 Allen Wrench
- Operator's Manual
- User's Manual
- Warranty Card
- Instruction Video
- Access Code Card
- Keypad Control Unit

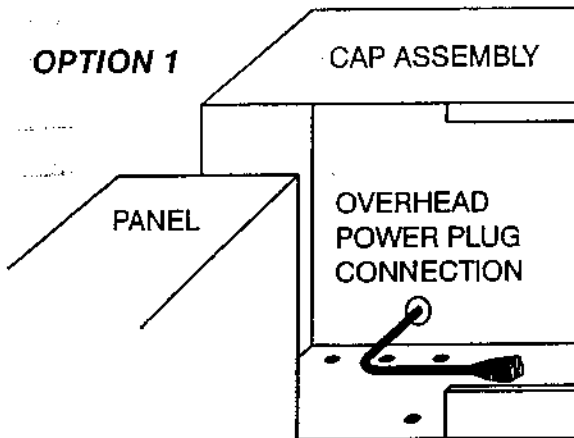
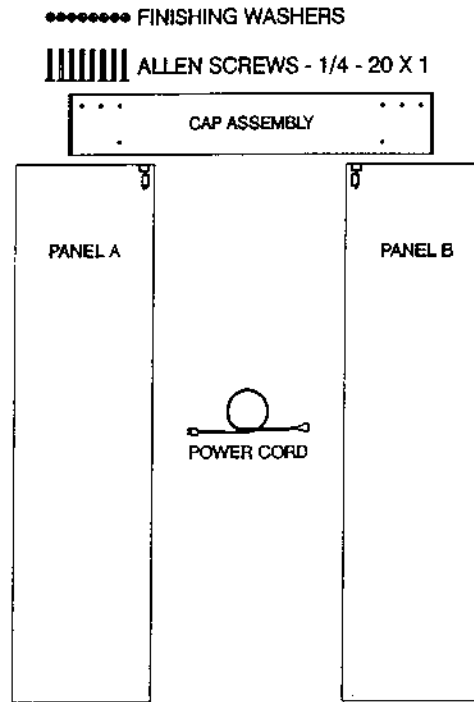

2. There are two options for routing the power cord.
 Option 1: Overhead power connection.
 -Remove the hole plug in the top of the Cap Assmebly.
 -Feed the female end of the power cord through the hole plug hole and route as shown. You may connect the power cord to the power module.
 -For weatherproofing, seal the plug hole.
 -This is a good time to determine the location of the Moveable Keypad Control Unit.

Option 2 - Floor level connection
 -Select panel closest to ac power outlet, stand panel up, drop male end of power cord down the side panel between the shield and the coil assembly. Position the female end of the cord so that it doesn't fall into the shield during assembly. The female end plugs into the power module.
 -Lay the panel down on the narrow side with panel connector close to the ground.
 -Excess cord should be pulled out the bottom of panel and into the notch in shield.

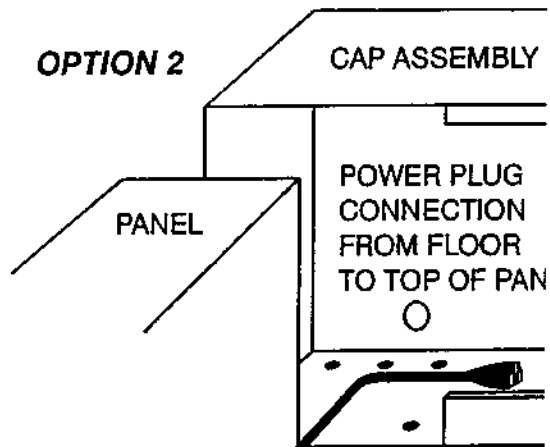

3.2. ASSEMBLY (CONT.)

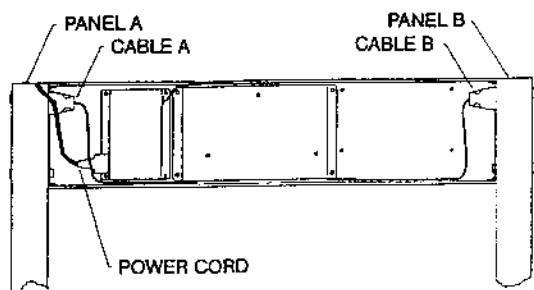

3. Position the Overhead Cap Assembly on the ground with the electronics module close to the ground. Slide the panel into the Overhead Cap Assembly.
4. Position the other Panel (NOTE: The Panel connectors must face each other) 30 inches away from the other Panel, then slide Panel into the Overhead Cap Assembly.
5. Align mounting holes and install 14 of the 22 screws and Finishing Washers. Tighten screws with the 5/32" Allen wrench.

6. With 3 or more people, lift to a vertical position and move to location.
7. Use the remaining screws and washers to attach the Overhead Cap Assembly, as shown.
8. Tighten all screws securely with Allen Wrench.

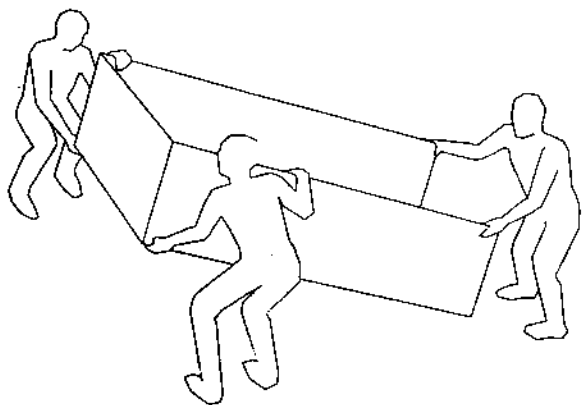

9. Unlock the locked panel in the Overhead Cap Assembly and connect Cable A and Cable B.
10. If the Moveable Keyboard Control Unit is to be attached to the outside of the Panels, select a location near an Allen Head screw and use that screw to attach the Moveable Keypad Unit.
11. Connect to the power line, and proceed with Installation Adjustments (See Page 11.)

4. SELF-DIAGNOSTIC TESTS

The Garrett Magnascanner MS 3500 LCD panel provides valuable information concerning the operation of this unit and the self-diagnostic program of which it is capable.

4.1 OPERATING INFORMATION

When the unit is placed into operation from the Standby Mode, the following information is reported:

1. *Serial Number* of the unit will be displayed.
2. *Software Version* of the unit will be displayed.
3. *50 Hz* or *60 Hz* will be displayed, indicating current status, if the unit is connected to power line AC.
4. *MASTER* or *SLAVE* will be displayed, indicating current status.
5. *CHANNEL* designation will be displayed, indicating current status.
6. Program and Sensitivity levels (*PROG D SENS 165* will be displayed initially), indicating current status.

4.1.1. SELF-TEST INFORMATION

After the sequence listed above is completed, as well as any time the system power is connected or any time the **OPERATE SELF-TEST** touchpad is pressed, a system self-test procedure will be performed. The following information will be displayed on the Display Panel, as necessary. *SELF-TEST* will be displayed as the unit tests itself automatically. *If any of the following 4 errors are detected, they will be displayed as shown below:*

Example: *SELF-TEST...4* (Indicates that Error 4 is occurring.)

4.1.2. CORRECTIVE ACTIONS

4.1.2.1. Error 1: Power failure

Check line voltage and externally connected devices.

4.1.2.2. Error 4: Receiver Balance Problem

Check for large metal objects near panels.

4.1.3.1. Error 5: Transmit Energy Out of Range

Check all connectors; check for very large object near Panel A.

4.1.3.2. Error 6: No Line Sync

If unit is in Slave Mode, check synchronization cable; otherwise, verify that the unit is set to Master.

If an error occurs, follow the procedures noted above and press **OPERATE** to retest. You will be prompted *SELF-TEST OK* when all functions are correct. If problems continue to occur, consult with your supervisor or factory representative.

The self-diagnostic/reporting cycle described above will be carried out automatically by the unit any time the **OPERATE** touchpad is pressed.

4.1.3. FATAL ERRORS

The system periodically performs several of the tests described above. Because Errors 1,4 and 5 severely limit or prohibit acceptable performance of the Magnascanner, they are considered *Fatal Errors*.

If a fatal error is encountered because of component failure, broken wire, etc., the audible alarm will sound and the LED display will begin to flash. To remedy the situation, press the **OPERATE** touchpad, which will initiate the self-diagnostic routine. Note the error(s) that will appear on the LCD and follow instructions stated above. If a solution is not obvious, it will be necessary to follow the repair procedure described on Page 21.

5. INSTALLATION ADJUSTMENTS

The Installation Adjustment Mode, which can be accessed *only through use of a four-digit code (Access Code #2)*, permits the Magnascanner MS 3500 to be set up properly for best performance in a given operational environment. Various options permit setting the unit for proper operation in conjunction with other walk-through units or for dealing with typical operation problems.

Default settings, preset at the factory, are indicated below for each of the functions in this mode. Use the + or — touchpads to regulate any of the functions.

To access the Installation Adjustment Mode for the first time, press the **ACCESS** touchpad and enter the factory preset code of 5678. Functions to be set will be displayed in the following sequence: Pressing **ACCESS** will scroll through these selections:

5.1. RECEIVER BALANCE

RX BALANCE will be displayed, indicating the balance of the receiving antenna. A number less than 50 is acceptable. If the number is greater, check the areas around the detector for large metal objects. If such objects are found, either move the object(s) or move the detector to eliminate a potential problem.

Press **ACCESS** for next adjustment or **OPERATE** to return to normal operation.

5.2. TONE

The alarm tone is initially set at a median level. Through use of the + and — touchpads the tone level can be raised or lowered. A corresponding number (1 to 9) will be displayed on the LCD panel and the tone that has been selected will be heard. When the desired tone is reached, press **ACCESS** to select the next adjustment or press **OPERATE** to return to normal operation.

5.3. SYNCHRONIZATION

Preset factory option is *MASTER*. See Multiple Unit Operation on Page 35 for directions on proper use of this option when it is necessary.

MASTER enables the unit to operate on its own internally generated synchronization from the power line.

SLAVE synchronizes the unit to the signal received from another Magnascanner on the Sync terminal (on the lower center of the Controller Circuit Board).

Press **ACCESS** for next adjustment or **OPERATE** to return to normal operation.

5.4. CHANNEL

This feature allows multiple units to operate in close proximity. It is recommended that when two (2) units are operated in close proximity that Channels A and B are used. If three (3) or more units are operated in close proximity, then use Channels A, C and D.

Do not use Channel B because it may conflict with Channel C. See Multiple Unit Operation on Page 35. Press **ACCESS** for next adjustment or **OPERATE** to return to normal operation.

5.5. **VIDEO FILTER**

This filter permits the unit to function effectively in proximity with video terminals of all types, computer, broadcast, closed circuit, etc. This filter may not apply to certain non-synchronous noise sources. Settings from 1 to 90 are possible through use of + and — touchpads. If noise is observed at your desired operating sensitivity, increment the Video Filter settings to locate the setting with least interference as observed by fluctuation of the Bar Graph.

Press **ACCESS** for next adjustment or **OPERATE** to return to normal operation.

5.6. **RELAY**

This feature allows the AC and DC relay circuits to be changed easily to Normally Open (N/O) or Normally Closed (N/C) to meet installation requirements. Use + and — touchpads to select *RELAY N/C* or *RELAY N/O* (See Page 36-38). Press **ACCESS** for next adjustment or **OPERATE** to return to normal operation.

5.7. **PASSCODES**

This feature allows management the option to use passwords and the keylock to protect access to the control setting or use only keys to protect access to control settings. Use + and - touchpads to select ON and OFF function.

ON requires the operator to use ACCESS CODES to gain access to Supervisor and Installation level adjustments.

OFF means the operator only has to press the ACCESS touchpad to make any changes of the equipment set-up. Each time the ACCESS touchpad is pressed, the operator can scroll through the MENU. The Moveable Keypad Control Unit should be locked inside the Overhead Cap Assembly.

Press **ACCESS** for the next adjustment or **OPERATE** to return to normal operation.

5.8. **ALTER ACCESS CODE #1**

This Supervisor Adjustments Code has been preset at the factory at 1234. To change this code:

1. Press the + touchpad.
2. Enter a new four-digit code.
3. The LCD display will prompt *REPEAT CODE*.
4. Enter the same four digits of the new code and it will be set and *CODE ENTERED OK* will be displayed. (If different digits are entered, the display will indicate *INVALID ENTRY*, and steps 2, 3 and 4 must be repeated.)

Press **ACCESS** for next adjustment or **OPERATE** to return to normal operation.

5.9. ALTER ACCESS CODE #2

This Installation Access Code has been preset at the factory at 5678. To change this code:

1. Press the + touchpad.
2. Enter a new four-digit code.
3. The LCD display will prompt *REPEAT CODE*.
4. Enter the same four digits of the new code and it will be set and *CODE ENTERED OK* will be displayed. (If different digits are entered, the display will indicate *INVALID ENTRY*, and steps 2, 3 and 4 must be repeated.)
5. Press **OPERATE** to exit the Adjustment Mode and enable the detector to be operated normally. If **ACCESS** is pressed, this Installation Adjustment cycle will be repeated, beginning with *Receiver Balance*.

Special Note

For maximum security it is recommended that both Access Code numbers be changed from the factory default settings and that the numbers be known only to those who use them. Record the new code numbers on the Access Settings card that accompanied this User's Manual. It is also suggested that codes be changed periodically, especially when any changes are made in personnel with access to the codes.

5.9.1. RESETTING FACTORY DEFAULT ACCESS CODES

If a code number is ever lost or forgotten, codes may be reset to factory default settings through the following procedure:

- Open the main cover of the Detection Unit;
- Remove the three (3) screws that hold the Controller Circuit Board cover;
- With power connected and the unit in Operate Mode press the Access Code Reset button in the upper center of the circuit board. (See drawing at top of Page 22.)
- *ACCESS CODE #1* will again be 1234 and *ACCESS CODE #2* will be 5678.

6. SUPERVISOR ADJUSTMENTS

Several adjustments may be made at the Supervisor's Level (Access Code #1). These are primarily program/sensitivity settings and the operation of the IR Sensor. These supervisor's adjustments can be accessed only through use of a four-digit code (See instructions for altering Access Code #1 under Installation Adjustments, Page 12.)

To access the Supervisor Adjustment Mode for the first time, press the **ACCESS** touchpad and the factory preset code of 1234. Factory default settings of *PROG D SENS 165* will be displayed on the LCD with the program designation blinking. Pressing the **ACCESS** touchpad will permit scrolling through these selections.

6.1. PROGRAM

The programs detailed on Pages 32 -34) have been developed for use by the Garrett Magnascanner MS 3500. These brief descriptions will give some indication of the intent of each program, but a final judgment on the setting of each individual unit should be determined by the intent of its installation. After Program number is accessed via the four-digit code, + touchpad can be used to increase the number, and the - touchpad to lower it. Press **ACCESS** for next adjustment or **OPERATE** to return to normal operation.

6.2. SENSITIVITY

This option permits the unit to be adjusted (range of 1 to 200) to the proper level of sensitivity within a chosen program. Press **ACCESS** until the *SENS* and number show on the LCD. Use the + and — touchpads to adjust the number. Sensitivity of detection is increased as the number gets larger, allowing alarm responses on smaller targets.

After the desired Sensitivity number has been selected, press **ACCESS** for next adjustment or **OPERATE** to return to normal operation.

6.3. ALARM LEVEL READING

Computerized circuitry of the Garrett Magnascanner MS 3500 permits the unit to report minimum sensitivity level required to cause an alarm for the particular metallic target that is being passed through . This information can then be used to regulate the unit.

Press the Access touchpad until PLEASE WAIT appears on the LCD Display, followed by ALARM LEVEL and a number. The target in question ;should then be passed through the unit. Note the Alarm Reading number that then appears on the LCD. This is the Sensitivity level that will be necessary for the unit to sound an alarm on this target. Press the + touchpad to reset the indicator after each measurement. It is recommended that several measurements of each object in question be made at various archway positions to obtain the optimum sensitivity level setting. Utilization of the Infrared Sensor is not required for operation of the Magnascanner and may be disabled if desired.

Press **ACCESS** for next adjustment or **OPERATE** to return to normal operation.

Types of Audio Alarms

Understanding the audio alarms the MS 3500 can sound will enable both supervisors and operators to understand the detector better and help assure totally accurate screening. Each of the two basic types of audio alarms is designed to call the operator's attention to current circumstances:

1. **Standard Alarm:** Occurs when red *ALARM* light appears and a targeted amount of metal is detected according to Program and Sensitivity levels.
2. **Warble Alarm:** Occurs when a large metal mass, such as a wheelchair, furniture or large metal container is moved through or near the Magnascanner. The large amount of metal has saturated the detector's receiver circuits and the warble alarm is an indicator that the operator should correct the situation before allowing anyone to pass through the metal detector.

7. SUPERVISOR RESPONSIBILITIES

7.1. CALIBRATION

Calibration settings of walk-through metal detectors are dependent upon individual security screening requirements and, therefore, **must be the responsibility of the screening installation**. Program and Sensitivity settings should be established at a level that permits the detector to detect all forbidden objects that can be reasonably expected to appear at a particular screening station. Actual forbidden objects should be used as targets for initial calibration.

An Operational Test Piece (OTP) is an object similar in size, shape and composition to the smallest forbidden target. Once the walk-through metal detector is properly calibrated, an OTP may be used to simulate the forbidden objects and verify calibration on a regular basis. The OTP thereby offers a generally accepted means of verifying calibration without the necessity of having on hand actual weapons at the screening station on a daily basis.

7.2. FAA TEST PIECE

Garrett manufactures an OTP made to the specifications of the U. S. Federal Aviation Administration (Garrett Accessory #1600600).

It is important to understand that OTPs come in various sizes, shapes and compositions, depending upon the calibration requirements of individual screening installations. The FAA OTP is similar to ones used for regular testing of the detection capability of metal detectors in United States airports.

If the requirements for your Magnascanner vary from FAA requirements, different test piece(s) should be considered.

7.3. TESTING

It is imperative that a standard test program be developed for walk-through metal detectors within a security system. The various tests should be made on a regular basis to ensure that each unit is properly calibrated and is detecting metal. The OTP has been designed to serve as a basic instrument for use in such a test program.

A test program should include passing the OTP and/or other objects through each metal detector at various specified heights and horizontal positions, with the OTP (objects) held in different orientations. The number of repetitions required at each level with corresponding successful alarms should be established, and this testing system should be adhered to consistently.

Included in the test procedure should be the requirement that the tester be free of all metallic items, including shoe shanks, prior to arming himself with the OTP. A hand-held metal detector can be used to confirm that the tester is "clean" of metallic items.

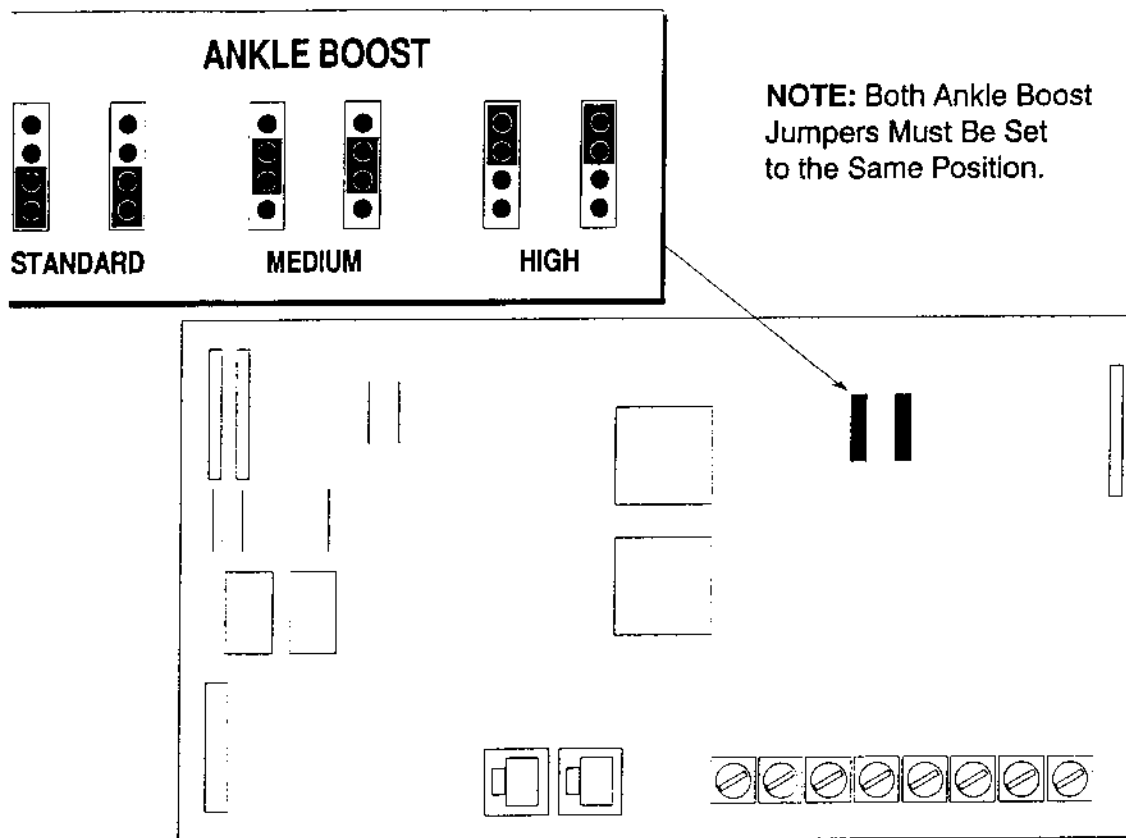

7.4. ANKLE BOOST

The MS 3500 incorporates the ability to adjust the sensitivity at ankle level without increasing sensitivity throughout the passageway. The factory setting is with standard ankle boost to allow easier passage of shoes containing metal shanks. Two additional levels of boost are available for higher levels of security.

This adjustment should be used only when sensitivity at ankle level needs to be increased.

7.4.1 PROCEDURE:

- Disconnect the unit from AC power source (switch off battery back-up module, if installed);
- Open access door of detection unit;
- Remove the three (3) screws that hold the controller cover;
- Move jumpers as shown in the above diagram to achieve the required level of boost (both jumpers must be set to the same level);
- Replace cover and reconnect power;
- Test unit to assure desired performance level.

7.4.2. APPLICATIONS:

- **High:** High sensitivity; low traffic volume
 - **Medium:** High sensitivity; high traffic volume
 - **Standard:** Normal sensitivity; high traffic volume
- Ankle-level sensitivity can be adjusted for any setting.

8. TECHNICAL SPECIFICATIONS

8.1. WEATHERPROOFING

There are several features of the MS 3500 that make it weatherproof:

- **Overhead Cap Assembly** - Housing all electronics, its one-piece design seals off the unit, leaving no openings through which moisture can penetrate.
- **Damage-Proof Materials** - All the materials used to assemble the unit were selected because of their non-reaction to weather capabilities.

8.2. CONSTRUCTION

Rugged, heavy-duty 3/32" armor aluminum plates with resilient corner caps for protection against maximum physical abuse. Construction design provides unit with maximum installation stability as well as weathertight operation.

8.3. ELECTRONICS

Digital-controlled pulse induction metal detector with microprocessors utilized in both detection and control circuitry. Designed for tailoring specific programs to fulfill various security applications.

Electronics are modular and designed for easy plug-in and change-out.

8.4. SELF-DIAGNOSTIC

Whenever unit is turned on, self-test of all systems is performed automatically, with any failures or problems reported (in words) on the LCD Display.

8.5. PROGRAM LEVELS

Ultimate versatility; 20 standard programs. Designed for tailoring specific programs to fulfill various security applications.

8.6. SENSITIVITY

1-200 per program for precise target selection.

8.7. MEMORY

All program selections and settings are maintained in electrically erasable non-volatile memory. The unit will maintain all settings even when disconnected from power. No battery is required for memory retention.

8.8. **CONTROL OUTPUTS**

Solid state switches (low voltage AC or DC) for operating external alarms and control devices.

8.9. **INDICATORS**

Ready Light indicates unit is operational; Alarm Light and audible alarm are activated when target amount of metal is detected; LED bar graph indicates amplitude of alarm signal.

8.10. **TAMPERPROOF**

All detection electronics can be secured behind a key-lock in the Overhead Cap Assembly. Optional dual-level access codes required to set or change all sensitivity settings and detection programs; one level for use by supervisors in selecting programs and sensitivity and the other for initial set-up and overall control; non-resettable sequence code logs all changes made whenever sensitivity codes are accessed. Audible alarm reports any unauthorized attempt at access. All connectors and plugs keyed to ensure proper connections.

8.11. **REGULATORY INFORMATION**

The Garrett Magnascanner MS 3500 meets or exceeds detection requirements of the National Institute of Law Enforcement and Criminal Justice Standards #0601.00, levels 1-5, and Federal Aviation Administration airport application specifications. Programs have been designed specifically to meet the three-gun test of the FAA and the requirements of the Undetectable Firearm Act of 1991. Conforms to the new European. The unit also complies with IEC standards for Safety Requirements for Electronic Measuring Apparatus and meets the Federal Communications Commission Class B standards for noise emission from commercial electrical equipment.

8.12. **PUBLIC SAFETY**

The Magnascanner has been tested in accordance to and meets the electromagnetic safety requirements of:

- Institute of Electrical and Electronics Engineers: "A Standard for Safety Levels with Respect to Human Exposure to Radio Frequency Electromagnetic Fields, 3 kHz to 300 GHz." IEEE C95.1 - 1991 Section 4.12.
- Occupational and Safety Health Administration: "Radiation Protection Guide," CFR 1910.97 section (2)i.
- National Institute of Law enforcement and Criminal Justice: "Standards for Walk-Through Metal Detectors for Use in Weapons Detection," NILECJ-STD-0601.00 section 4.11.
- Canada Health and Welfare: "Performance Standards (Walk Through)," RPB-SC-18 section 3.2.2 which addresses the issue of electromagnetic effects to cardiac pacemakers.

Our research has produced no information which would indicate that the Garrett products would have any adverse effects on medical implants, pregnancy, recording media, or magnetic strips. Any additional recommendations or directives issued by personal physicians or medical equipment manufactureres should be followed. If, for any reason (doctor's orders, for instance), a patron objects to being scanned with a metal detector, it is recommended that an alternative procedure (manual hand search, non-admittance, etc.) be a part of the overall security plan.

8.13. **ANKLE BOOST**

Multiple coil design provides three intensity levels of ankle boost sensitivity to ensure uniformity of screening in all security applications.

8.14. **INTERFERENCE REJECTION**

100% sensor coil Faraday shielding; special Garrett built-in circuitry for noise suppression and ignoring x-ray monitor horizontal sync; RFI-EMI filters provide attenuation from 10 MHz to 1000 MHz.

8.15. **SYNCHRONIZATION**

Multiple frequencies permit several Magnascanners to operate simultaneously in close proximity.

8.16. **ELECTRICAL**

Fully automatic 100 to 240 VAC, 50/60 Hertz, 5 watts. Power supply meets UL, CSA, TUV and VDE standards.

8.17. **MASKING**

Microprocessor programming designed to eliminate the problem of detection signals from two or more targets canceling each other.

8.18. **DIMENSIONS**

- **Passageway interior:**
 - Width 30" (0.76m)
 - Height 80" (2 m)
 - Depth 20" (0.5m)
- **Overall exterior:**
 - Width 50" (1.3m)
 - Height 89" (2.3m)
 - Depth 20" (0.5m)
- **Shipping:**
 - Width 25" (64cm)
 - Height 55" (140cm)
 - Depth 7.5" (19cm)
 - Weight 218 lbs. (58.6 kg)
 - Assembled Weight 166 lbs.
- **Sides, 2 boxes each**
 - 25" 64cm)
 - 92.5" (235cm)
 - 11" (28cm)

MAGNASCANNER MS 3500
OWNER'S MANUAL

•Overhead Cap Assembly 54 3/4"x26"x10 1/4"

•Panel 93 1/4"x25 3/4"x11"

• Operating temperatures:-4F (-20C) to +158F (70C)

• Humidity: To 95% noncondensing.

•Throughput rate: Not limited by electronics.

•Optional features: Battery Module (#2225700) allows 12v battery operation for up to 20 hours on one charge; Operational Test Piece (#1600600), designed to simulate in size, shape and composition the smallest forbidden object for testing and verifying calibration settings of walk-through detectors; Desktop Remote Control (#2225600) with standard 50-ft. length of cable (300 ft. maximum). Contains LED indicators, LCD read out and touchpads for easy operation. Floor mounting kit (#1604000).

MAINTENANCE & REPAIR

9.1. **PERIODIC MAINTENANCE**

Periodic maintenance of the equipment requires only inspection for loose or damaged parts and cleaning of the exterior surfaces.

- Open the access door of the Overhead Cap Assembly and check that all connectors are snapped securely and that all screws and nuts are in place.
- Check to make certain that the archway sits flat on the floor and does not sway or rock.
- If the power cord or cable to remote devices is at floor level, check for frayed or broken wires. Replace immediately.
- Clean exterior surfaces with mild soap and water only. If a solvent is necessary for heavy cleaning, use only denatured alcohol.
- Test the detector daily, or whenever the environment changes.

9.2. **REPAIR**

There are no user-adjustable controls inside the unit. Should the equipment ever fail to perform properly, contact the seller for the name of the nearest field service representative, or contact the factory.

Because the equipment is of modular design, repairs can often be made through the replacement of these plug-in modules. An illustrated parts list follows for your convenience.

If problems are site-related, see Page 6, or contact the factory for assistance. Many times these problems may be resolved through the adjustment of the equipment or surrounding objects.

9.3. **MODULE REPLACEMENT**

The system is built as a system of modules, each of which can be easily removed and replaced. These modules are tested and calibrated independently, and there is no need for adjustment of any other electronic assembly when a module is replaced. It is necessary to test the system carefully to verify operation and the suitability of the product after any component replacement.

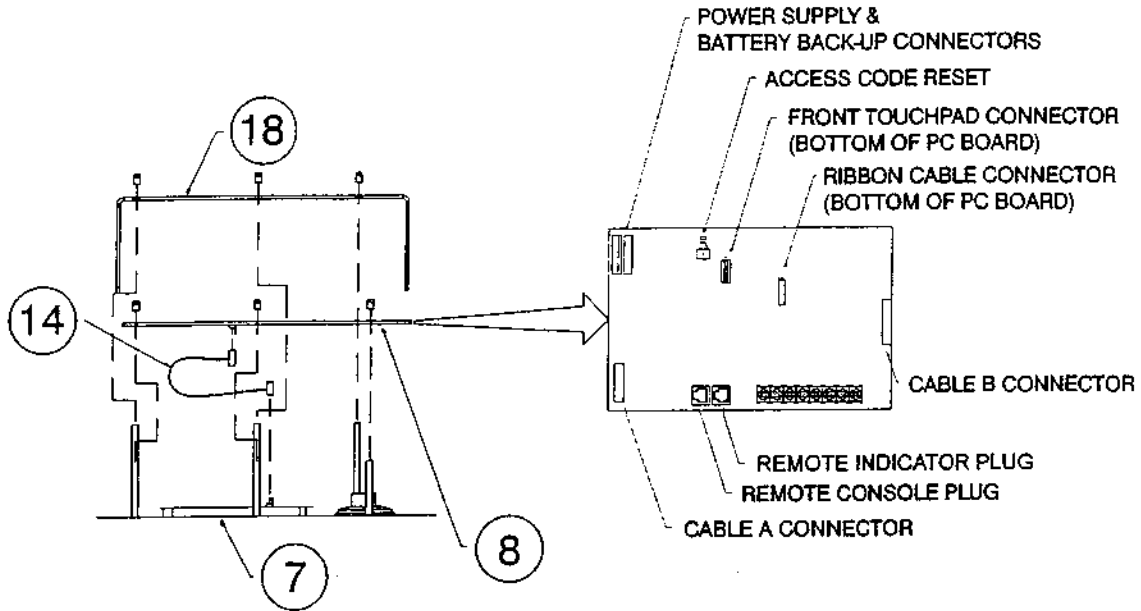

DETECTION MODULE

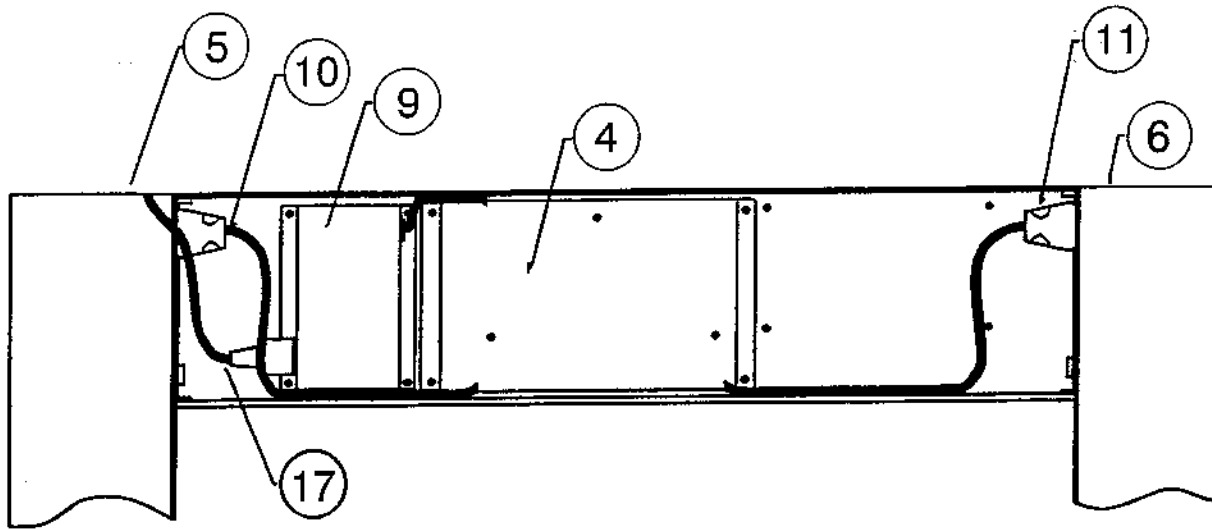

9.4. REPLACEMENT PARTS

ITEM	DESCRIPTION	PART #	QTY
1	Access Code Card	1562300	2
2	Operation Manual	1531000	1
3	VHS Video Tape	1672700	1
4	Detection Module	2300900	1
5	Panel A	2231600	1
6	Panel B	2231700	1
7	Display Circuit Board Assembly	2337400	1
8	Controller Circuit Board Assembly	2338000	1
9	Power Supply Module 100-240 vac	2326300	1
10	Cable Assembly A	2403800	1
11	Cable Assembly B	2403700	1
12	Speaker Assembly	2405100	1
13	Lock Assembly	9820900	1
14	Ribbon Cable-16 conductor, 6"	9504700	1
15	Keypad Controller Board Assembly	2337300	1
16	Touchpad	9418000	1
17	Power Cord 110V 17'	9411500	1
18	Controller Cover	9984500	1
19	Finishing Washer	9820500	*
20	Screw Allen 1/4-20x1"	9824710	*

* AS NEEDED

9.5 **WARRANTY**

Garrett Electronics, Inc. ("Garrett") warrants that this Magnascanner MS 3500 weapons/metal detector is protected by the following limited parts and labor warranty for a period of 24 (twenty-four) months ("The Warranty").

During this 24-month period Garrett will inspect and evaluate all security equipment returned to its authorized repair station or factory to determine if the equipment meets Garrett's performance specifications. Garrett will repair or replace at no charge to the owner all parts determined faulty. This Warranty does not cover batteries nor any and all failures caused by abuse, tampering, theft, failure due to weather, battery acid or other contaminants and equipment repairs made by an unauthorized party.

This warranty is expressly in lieu of all other warranties, expressed or implied, including the warranty of merchantability or fitness for a particular purpose.

The Buyer acknowledges that any oral statements about the merchandise described in this contract made by Seller's representatives, if any such statements were made, do not constitute warranties, shall not be relied upon by the Buyer and are not a part of this contract for sale. The entire contract is embodied in this writing. This writing constitutes the final expression of the parties' agreement and is a complete and exclusive statement of the terms of this agreement.

The parties agree that the Buyer's sole and exclusive remedy against Seller shall be for the repair and replacement of defective parts. The Buyer agrees that no remedy (including, but not limited to, incidental or consequential damages for lost sales, lost profits, injury to person or property) shall be available to him.

10. **OPERATING INSTRUCTIONS**

This Manual is designed to provide all necessary information required for operation of the Garrett Magnascanner MS 3500 walk-through metal detector. It contains four sections:

- Description of the detector;
- Description of all controls;
- Operators' responsibilities;
- Basic operating instructions.

10.1. **BASIC INSTRUCTIONS**

In addition to following all operating procedures as directed by supervisors the operator of a Magnascanner MS 3500 detector has only these responsibilities:

- Assure that the detector is always operating properly;
- Respond to all alarms.

NOTE: IF THE MOVABLE KEYPAD IS LOCKED IN THE OVERHEAD CAP ASSEMBLY, OPERATOR DOES NOT HAVE ACCESS TO STANDBY/OPERATE AND VOLUME ADJUSTMENTS. THIS IS DONE TO PROVIDE MAXIMUM SECURITY.

10.2. **LCD REPORTS INFORMATION**

The LCD on the Movable Display Keypad Control Unit reports information concerning the unit's calibration and operation. This includes program data, sensitivity settings, operator settings and fault indication. A bright LED bar graph, easily visible from a distance, reports detection levels and separate lights indicate ready and alarm conditions. All regulation and control functions are "self-prompting" with necessary commands shown automatically on the LCD. The unit also features the capability to report a traffic count on its LCD.

Exact control of the unit's sensitivity is assured by a system with 200 precise and repeatable steps for each program level, regulated by state-of-the-art touchpads and reported visually on the LCD. Improved security of the unit's detection settings comes from a totally new system of access codes and key-lock access.

Management has the option to turn access codes on or off. Two levels of codes are used to maximize security, while the Magnascanner's circuitry provides precise accuracy of calibration never before achieved. Access Code #1 is used by supervisors for selecting programs and sensitivity, with Access Code #2 designed for initial set-up and overall control. All settings are encoded by touchpads and stored in a resettable memory.

Security of the unit's calibration settings is further protected by a non-resettable sequence code that allows supervisors to keep a log of all changes that are ever made to the program, sensitivity or set up, as well as any unsuccessful attempt at changing them. In addition, a tamper indication reports any unauthorized attempts at access.

A complete and automatic self-diagnostic program is carried out by the Magnascanner MS 3500 each time the OPERATE touchpad is pressed. In addition, the detector utilizes fail-safe self-testing circuitry that enables it to identify and report automatically the failure of any element that would affect operation of the unit.

10.3. READY LIGHT

This green light appears when full power has been turned on and the unit is ready to detect. The light will also indicate when an individual inspection has been completed by the unit and it is ready to accept the next person. Operators should make certain the green light is visible before any individual is permitted to pass through the detector.

10.4. ALARM LIGHT

This red light appears when the unit detects a targeted amount of metal on an individual, according to specifications of the Program and Sensitivity levels that supervisors have entered into its circuitry. This light will appear even when sound volume is inaudible. Operators should follow instructions of supervisors in responding to alarms. It is absolutely necessary that the cause of EVERY ALARM be determined.

10.5. TYPES OF AUDIO ALARMS

The MS 3500 has two types of alarms. Each of these unique alarms is designed to call the operator's attention to current circumstances:

10.5.1. STANDARD ALARM

Occurs when red ALARM light appears and targeted metal is detected according to Program and Sensitivity levels.

10.5.2. WARBLE ALARM

Occurs when a large metal mass (a wheelchair) moves through or near the Magnascanner. When a large amount of metal saturates the detector's receiver circuits the warble alarm indicates that the situation should be corrected before anyone passes through the detector.

10.6. BAR GRAPH

This LED display indicates the amount of any metal passing through the unit.

10.7. TOUCHPADS

Eight touchpads on the Movable Display Keypad Control Unit perform all control functions.

10.7.1. STANDBY

When this touchpad is pressed, the unit goes into a low power mode, ready to be returned to full operation when the OPERATE pad is touched. Operators should use all touchpads only as instructed by supervisors.

10.7.2. OPERATE

When this touchpad is pressed, the Magnascanner MS 3500 activates all circuits, initiates a self-diagnostic program and places the unit in the Operate Mode within 15 seconds. This diagnostic program for instant fault detection can be activated at any time by touching this Operate pad. If any faults are ever found, they will be immediately reported on the LCD display. (See Page 9-10.)

10.7.3. LOG ACCESS

When this touchpad is pressed, the Access Log Number is displayed on the LCD display. Each time the Installation Adjustment or Supervisor Adjustment mode is accessed, the log count advances by one number. It is recommended that a written notification be made on the Operations Worksheet (see Page 31) whenever the Access Code is assessed, explaining reasons for the access.

10.7.4. VOLUME

When this touchpad is pressed, the volume level of the unit's audible alarm will be displayed on the LCD display. By using the + and - touchpads, operators can raise or lower the volume.

10.7.5. + AND -

These touchpads will be used to increase or decrease various numerical settings and for certain On/Off functions.

10.7.6. PROGRAM

When this touchpad is pressed, the settings for Program and Sensitivity will appear on the LCD display.

10.8. ACCESS TOUCHPAD

Operators need never touch this control.

This touchpad is for supervisory management personnel only. It permits changing the Program/Sensitivity codes. It's also used to control such functions as synchronization of multiple units, pulse frequency and tone. It also protects security of control settings by maintaining a non-resettable sequence code that indicates any access attempts. A Tamper Alarm sounds within 10 seconds after the Access touchpad is pressed unless a proper access code is entered. Follow supervisors' instructions concerning response to this Tamper Alarm. Tamper alarm only occurs when access codes are selected "ON".

10.9. OPERATORS' RESPONSIBILITIES

The primary responsibility of any operator is to follow all supervisory instructions.

These directives will govern the response of operators to alarms and other situations that will be encountered. The basic continuing responsibility of the operator will be to ensure that the Magnascanner MS 3500 operates properly at all times as indicated by its LCD panel and that **ALL** Alarms are investigated.

Remember that the cause of every alarm **MUST** be determined.

10.10. SUPERVISORS RESPONSIBILITIES

- To set the Program and Sensitivity settings.
- Control the synchronization of multiple units, channel and tone.
- To train operators in the proper use of the MS 3500.

10.11. OPERATORS INSTRUCTIONS

1. Operator that does not have access to Movable Key Pad can only observe:

- A. Ready Light
- B. Alarm Light
- C. LED
- D. Nuisance Alarms

2. All personnel who are associated with the detector should watch a video presentation on the Magnascanner MS 3500 in addition to studying this Operators Manual. Carefully following the instructions in the Manual will help ensure the security of any facility this walk-through detector is expected to protect.

10.12. READY LIGHT

The green **READY** light, located below and at left of the LED Bar Graph indicates that the Magnascanner is operating. When the green light is showing, power has been turned on and the unit is prepared to detect metal.

The green Ready light must always be on before anyone is permitted to enter the archway for inspection.

The green light will "wink" whenever anyone breaks the optical beam across the archway or whenever there is a noise "spike." If the green Ready light should ever go off and remain off, however, the operator should immediately press the **OPERATE** touchpad. The detector will then institute a self-test program with results reported on the LCD display. All traffic through the unit must be halted until the green **READY** light again appears and remains constant.

10.13. ALARM LIGHT

The Red ALARM light is located to the right of the LED bar graph on the Overhead Cap Assembly. When an alarm sounds and the Red ALARM lights go on, the person passing through the detector at that time must either be scanned immediately with a Super Scanner or Enforcer G-2 hand-held metal detector or asked to walk through the unit again after removing metal objects from body and clothing.

If an alarm sounds after the person has removed metal objects, hand scanning is mandatory to find the source of metal sounding the alarm. This metal causing the alarm must always be found before a person can be allowed to proceed.

10.14 NUISANCE ALARMS

Any metal detector will occasionally register what is called a nuisance alarm, triggered by electrical or mechanical noise from the environment.

No detector is immune from nuisance alarms caused primarily by electrical disturbances from large motors, computers, fluorescent lighting or many other sources. An operator should not be overly concerned about nuisance alarms, but should accept that they can happen and be ready for them. Of course, it will be necessary to retest any person passing through the detector when a nuisance alarm is believed to have sounded.

On rare occasions, a nuisance source might trigger the alarm just as someone is passing through the detector. An operator should never try to guess about the source of the alarm, and it should never be assumed that the alarm is a nuisance. There have been occasions when an individual would intentionally bump against a detector while passing through and try to blame an alarm on the bump.

If an alarm sounds for any reason, while a person is passing through the archway, that person must be asked to walk through the unit again and/or be examined for metallic objects with a hand-held detector. There will be no exceptions.

10.15. SUMMARY

It is important that all operators study the guidelines in this section carefully and remember their basic responsibilities for operating the Magnascanner MS 3500 as stated on the first page:

- Make sure power is turned on;
- Make certain the unit is operating properly;
- Adjust volume of the alarm;
- Respond to all alarms.

Operators that do not have access to the Movable Display KeyPad Control Unit are responsible for:

- Making sure that green Ready Light is on;
- Making sure that the unit is operating properly by performing daily test according to security plan;
- Respond to all alarms.

Most important of all, is the operator's responsibility to make certain that every alarm be investigated and that the reason for that alarm be determined.

There is no finer walk-through metal detector in the world than the Magnascanner MS 3500. But, in the end, even an electronic device as sophisticated as this is only a tool. Ultimate success of its operation is dependent on:

- The training and diligence of the men and women who operate it;
- The system of which it is a part.

11. ADDITIONAL INFORMATION

11.1. OPERATIONS WORK SHEET

Location: _____

Serial Number: _____

Version: _____

Date	Seq. Number	Prog	Sens	Changes Made	Initials
_____	_____	_____	_____	_____	_____
_____	_____	_____	_____	_____	_____
_____	_____	_____	_____	_____	_____
_____	_____	_____	_____	_____	_____
_____	_____	_____	_____	_____	_____
_____	_____	_____	_____	_____	_____
_____	_____	_____	_____	_____	_____
_____	_____	_____	_____	_____	_____
_____	_____	_____	_____	_____	_____
_____	_____	_____	_____	_____	_____
_____	_____	_____	_____	_____	_____
_____	_____	_____	_____	_____	_____
_____	_____	_____	_____	_____	_____
_____	_____	_____	_____	_____	_____
_____	_____	_____	_____	_____	_____
_____	_____	_____	_____	_____	_____
_____	_____	_____	_____	_____	_____
_____	_____	_____	_____	_____	_____
_____	_____	_____	_____	_____	_____

11.2. PROGRAMS

Note: Although different settings are required for different applications, the manufacturer finds Program D most effective for high volume high security; Program A for low volume maximum security; and Program 9 in loss prevention situations and in cases where noise problems limit performance of custom programs. It is the responsibility of the user to select and implement that program which is best suited to a particular situation.

11.2.1. PROGRAMS 1-10

- Standard programs designed to detect a broad range of objects.
- Lower numbered programs are primarily for the detection of ferrous objects such as iron, most stainless steel, etc.
- High numbered programs are primarily for the detection of conductive objects such as those made of aluminum, zinc, lead, etc.
- Programs 7-9 provide a balanced response to ferrous and conductive objects.
- Program 9 provides good discrimination against foils (cigarette packs, etc.).
- Immunity to external noise makes these programs useful in noisy environments.
- Overall discrimination is poor.
- Recommended applications include loss prevention and installations where specific objects need to be emphasized or ignored.

11.2.2. PROGRAMS 11-15

- Standard programs designed to detect a broad range of objects.
- Lower numbered programs are primarily for the detection of ferrous objects such as iron, most stainless steel, etc.
- Higher numbered programs are primarily for the detection of large conductive objects such as those made of aluminum, zinc, lead, etc.
- Programs 14 and 15 provide a balanced response to ferrous and conductive objects.
- Immunity to external noise is poor, making these programs difficult to use in noisy environments.
- Overall discrimination is moderate.
- Recommended applications include loss prevention and installations where specific objects need to be emphasized or ignored.

11.2.3. PROGRAM A

- Custom program designed to detect the broadest range of objects.
- Emphasis of detection is on conductive objects. This program provides the highest level of security available in the MS 3500.
- Immunity to external noise is moderate, making this program usable in most environments.

- Discrimination is poor.
- Recommended applications include prisons and other installations where volume requirements allow thorough inspection of each individual.

11.2.4. PROGRAM B

- Custom program designed to detect ferrous and conductive objects equally.
- Immunity to external noise is moderate, making this program usable in most environments.
- Discrimination is moderate.
- Recommended applications include general security.

11.2.5. PROGRAM C

- Custom program designed to detect ferrous and conductive objects equally.
- This program is optimized for the three-gun test of the Federal Aviation Administration (FAA).
- Immunity to external noise is moderate, making this program usable in most environments.
- Discrimination is good, providing the highest throughput rate.
- Recommended applications include airports, schools, courtrooms and other high volume installations.

11.2.6. PROGRAM D

- Custom program designed to detect ferrous and conductive objects.
- Emphasis of detection is on conductive objects.
- This program provides a level of security that exceeds FAA requirements.
- Discrimination is moderate to good.
- Recommended applications include airports, schools, courtrooms and other installations requiring the maximum possible security in high volume operation.

11.2.7. PROGRAM E

- Custom program designed to detect ferrous and conductive objects. Emphasis of detection is on conductive objects.
- Immunity to external noise is moderate, making this program usable in most environments.
- Discrimination is moderate to good.
- Recommended applications include loss prevention.

CAUTION:

The Magnascanner MS 3500, as with all walk-through metal detectors, has several available programs. The user may find that a different application (weapons detection, loss prevention, high or low volume) may be best served with one or more of these programs.

Garrett engineers have developed a special program (Program D) which minimizes the cancellation (masking) effect which can be experienced when certain materials of differing composition pass through the archway. It is recommended that this program be considered any time the system is employed for weapons detection.

RECOMMENDED PROGRAMS

When to Use	Applications	Program	Metal Types	Discrimination
High Volume Traffic	Airports, Special Events, Private Businesses, Gov't Buildings, Schools, Courthouses, Hospitals, Corporate Security	D	Detects FAA test guns, plus the multicomposition subject to masking Alloy types, Iron, Aluminum, Steel	Good to Excellent Prevents masking Designed to ignore common pocket items (High Throughput)
When maximum throughput is required	Airports	C	Specially tuned to detect FAA 3 guns Stainless Steel, Iron, Aluminum	Excellent Designed to ignore common pocket items (High Throughput)
Maximum security screening	Correctional Facilities, Loss Prevention, Law Enforcement	A	All Metal Ferrous Non-Ferrous	None (Low Throughput)
Alternative when A,C,D can't be used because of extreme environmental conditions	All Applications	9	FAA 3 gun Ferrous Non-Ferrous	Mild (Low Throughput)

NOTE: THESE ARE ONLY RECOMMENDED PROGRAMS. IT IS THE END USER'S RESPONSIBILITY TO TEST AND VERIFY THAT THE SELECTED PROGRAM MEETS THEIR SECURITY PLAN OBJECTIVES.

11.3. MULTIPLE UNIT OPERATION

There are several options for installation of multiple units in close proximity. The following list of examples will be helpful in determining an appropriate method of connection.

For proper operation, each walk-through metal detector must be set to receive no interference from adjoining units. This can be determined by observing the bar graph indication of one unit while switching the remaining unit(s) from *Standby* to *Operate*. If the noise flicker increases on the *BAR GRAPH* of a unit, then it may be necessary to select another set-up.

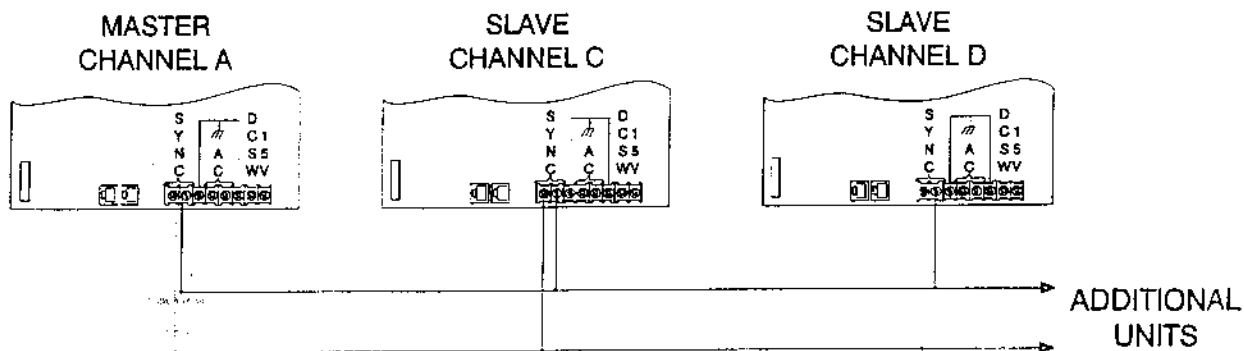

11.3.1. CASE I

Description:

- Two (2) units which interfere with each other;
- Both units plugged into same power line (same circuit breaker).

Procedure:

- Set both units to *MASTER* ;
- Set one unit to *CHANNEL A* ;
- Set one unit to *CHANNEL B*.

11.3.2. CASE II:

Description:

- Three (3) or more units that interfere with each other;
- All units plugged into same power (same circuit breaker).

Procedure:

- Set all units to *MASTER* ;
- Set end unit to *CHANNEL A* ;

- Set next unit to *CHANNEL C* ;
- Set next unit to *CHANNEL D* ;
- Repeat pattern of *CHANNELS A, C, and D* for any additional units.

11.3.3. CASE III: MULTIPLE UNIT OPERATION

Description:

- Three (3) or more units that interfere with each other;
- Units not plugged into the same power line or units with battery back-up option which may be required to operate in the absence of AC power.
- With the exception of the first and last units, the SH-3 jumper must be removed. This jumper is located on the Controller Board Assembly. Refer to the drawing for exact location.

Procedure:

- Disconnect units from power line;
- Open Access Door of Detection Unit;
- Remove three (3) screws that hold controller cover;
- Use synchronization wire (18 to 24-gauge, 2 conductor) between units; connect as shown;
- Set the end unit to *MASTER CHANNEL A* and ensure that this unit is connected to either AC power or battery power at all times;
- Replace covers and reconnect power;
- Set all other units to *SLAVE*;
- Set the remaining units to *CHANNELS C and D* as shown;
- Repeat pattern of *CHANNELS A, C, and D* for any additional units.

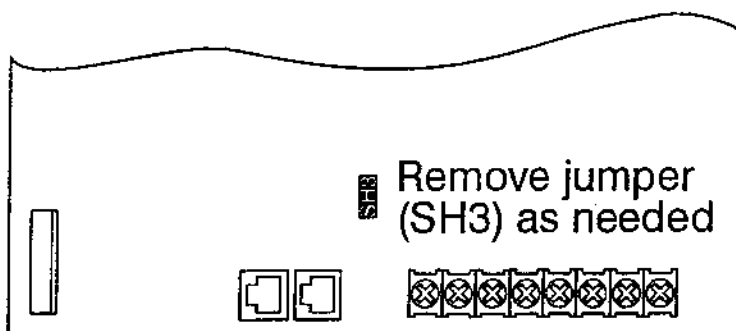

11.4 AC&DC CONTROLS

11.4.1. AC CONTROL

Connection of an external alarm, locking device or other component may be made as shown below. The optically-isolated triac output will conduct only during the time that the Red *ALARM* light is illuminated. It is recommended that the control not exceed 48Vrms and 100mA. The output is electrically isolated from ground.

Procedure

- Disconnect from AC power;
- Open Access Door of detection unit;
- Remove three (3) screws that hold controller cover;
- Connect the relay or device to control;
- Replace cover and reconnect power.

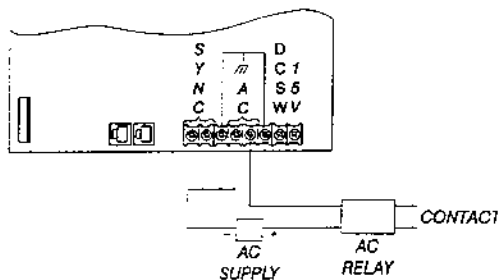

11.4.2. DC CONTROL

The three drawings at the right illustrate alternate methods of connecting an external device which has requirements of low voltage direct current. The output is an open collector configuration capable of switching 15V at 100mA or less, which includes connections to computing devices and other equipment requiring low level DC.

11.4.2.1. Case I: Use internal power

- Disconnect from AC power;
- Open Access Door of detection unit;
- Remove three (3) screws that hold controller cover;
- Connect the relay or device to control, as shown at right;
- Replace cover and reconnect power.

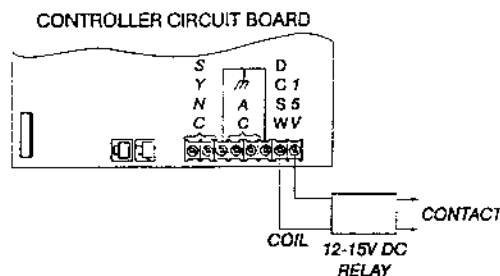

11.4.2.2. Case II: Use external power

- Disconnect from AC power;
- Open Access Door of detection unit;
- Remove three (3) screws that hold controller cover;
- Connect the relay or device to control, as shown at right;
- Connect the relay or device to control, as shown at right;
- Replace cover and reconnect power.

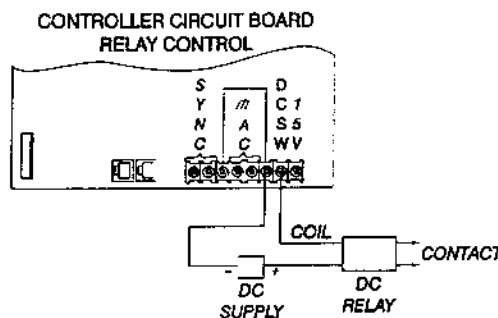

11.4.2.3 CASE III: EXTERNAL LOGIC CONTROLS

- Disconnect from AC power;
- Open locked door of Overhead Cap Assembly;
- Remove three (3) screws that hold controller cover;
- Connect the relay or device to control;
- Replace cover and reconnect power.

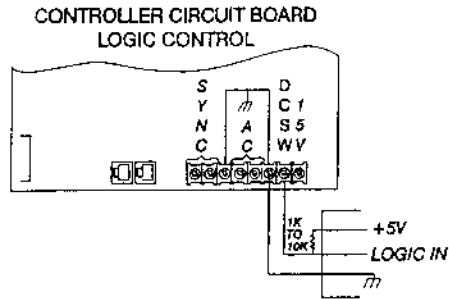

11.5. BATTERY BACK-UP MODULE (OPTIONAL)

This optional module is a field-installable assembly that provides power to operate the Magnascanner MS 3500 for up to twenty (20) hours on a fully charged battery. System software includes an alarm feature that alerts the operator to a low-battery condition. This ensures that the unit continues to operate at its peak performance level.

A switch is provided on the side of the battery module to fully disconnect battery power. This switch should be set to its *OFF* position anytime the system is being stored and anytime the system is not in use and is not connected to AC power for more than 24 hours. Standby circuitry will discharge a fully charged set of batteries in about ten (10) to fifteen (15) days whenever the switch is not turned off.

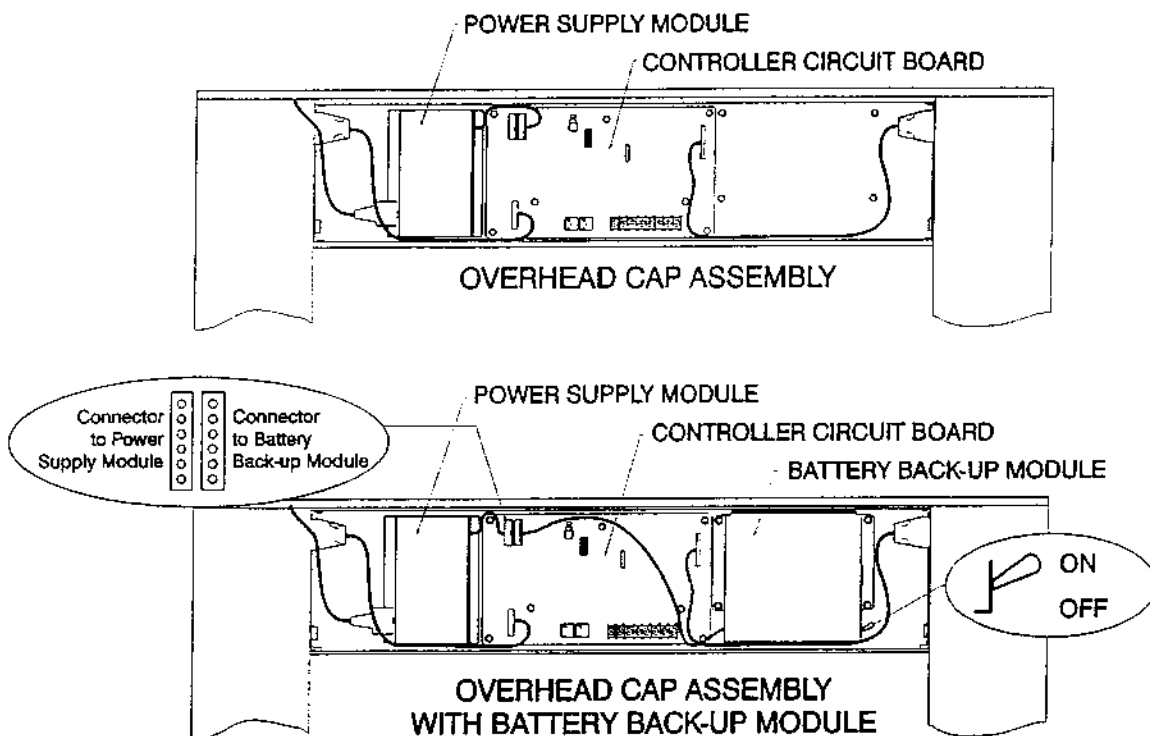

11.5.1. INSTALLATION

1. Open locked door of the Overhead Cap Assembly;
2. Disconnect the AC power plug from the Power Supply Module;
3. Remove the three (3) screws that hold the Controller Module Cover;
4. Remove the four (4) acorn nuts that are attached to the Battery Pack Module mounting studs;
5. Install the Battery Pack Module and replace the acorn nuts;
6. Disconnect the Power Supply Module connector on the upper left of the Controller Circuit Board;
7. Reconnect the Power Supply Module and Battery Pack Module as shown;
8. Reassemble the system and test.

11.6. **DESKTOP CONTROL (OPTIONAL)**

A complete remote console with all control functions that are available on the overhead panel is available for monitoring and controlling functions of the Magnascanner MS 3500 from a location apart from the archway.

This remote console is connected to the overhead unit with telephone-type cable and RJ 45 connectors which can be easily concealed behind overhead panels or in 1/2-inch conduit. The remote control receives its power from the main detector unit.

Pressing a touchpad on the remote console achieves the same result as pressing the same touchpad on the overhead panel, except for the **VOLUME** and **TONE** adjustment.

Regulating alarm volume and tone must be done separately at the remote console and at each unit it controls. This enables the audio to be set separately at the required levels for the console and archway. A 50-foot cable is standard, but custom lengths are available.

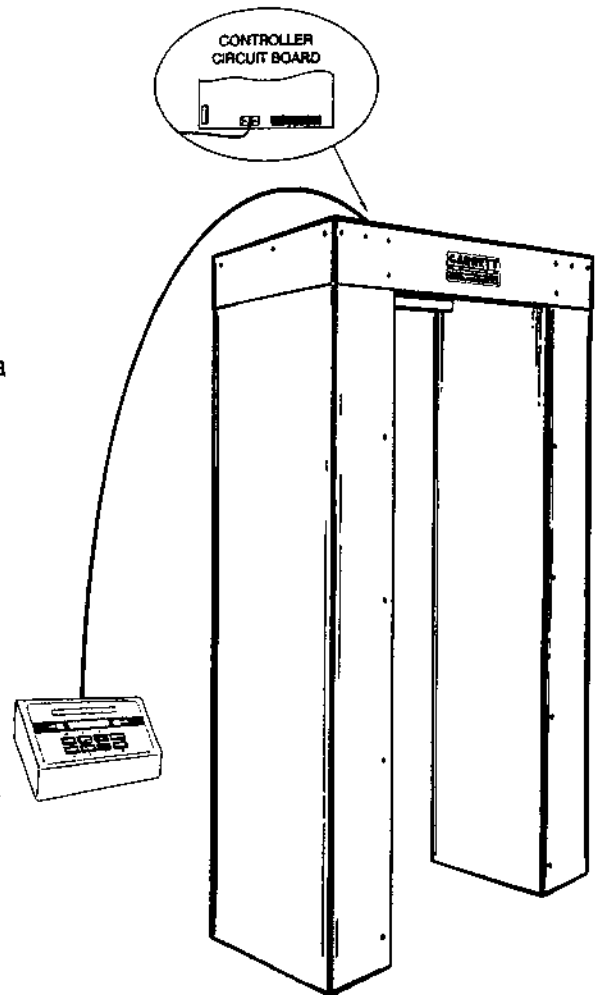

11.6.1. **INSTALLATION**

- With power disconnected locate archway and console in their desired locations;
- Locate connecting wire and protect from tampering or vandalism, as necessary;
- Plug the wire into the rear of the console;
- Open the Access Door of the detection unit;
- Remove three (3) screws that hold the controller cover;
- Plug the wire into the Circuit Board connector as shown on Page 22;
- Replace covers and connect to power.

12. ELECTRICAL WIRING REQUIREMENTS

MODEL #1167200 MAGNASCANNER MS 3500

Comes with a standard American ground power cord. If the plug must be replaced or removed to hardwire to an AC junction box, use the following wire list:

Green	To Ground
Black	To Line Hot
White	To Line Neutral